

Sample Boards 2022

LAST UPDATED: 24-07-2023

DEMO



Sample Boards

22-001 FFC50 to FFC50 Constantan Bestaat nog niet !!!!	3
22-002 Sample Board Christian Prosko	4
22-004 Sample Board Hans Beukers	5
22-006 Test Board Sample Impedance Matching	6
22-020 Power Splitter for Multichannel diplexer	8
22-021 SPI Option power breakout box.....	9
22-025 FFC50 to FFC50 swap	11
22-026 LD400 Filterboard Will-Nico improved	12
22-027 Plating Current Source	13
22-028 Remote Valve Control	14
22-030 Expanded FFC Cryo-mux	14
22-031 Sample Board Laurens Feije.....	16
22-032 Sample Board D. van Driel	17
22-033 Sample Boards Martijn Zwanenburg	18
22-035 FFC50 to FFC50 swap Maxim	20

22-001 FFC50 to FFC50 Constantan

Bestaat nog niet !!!!!

size (LxWxT): 200/240/280/350/400/500 x ? x ? mm

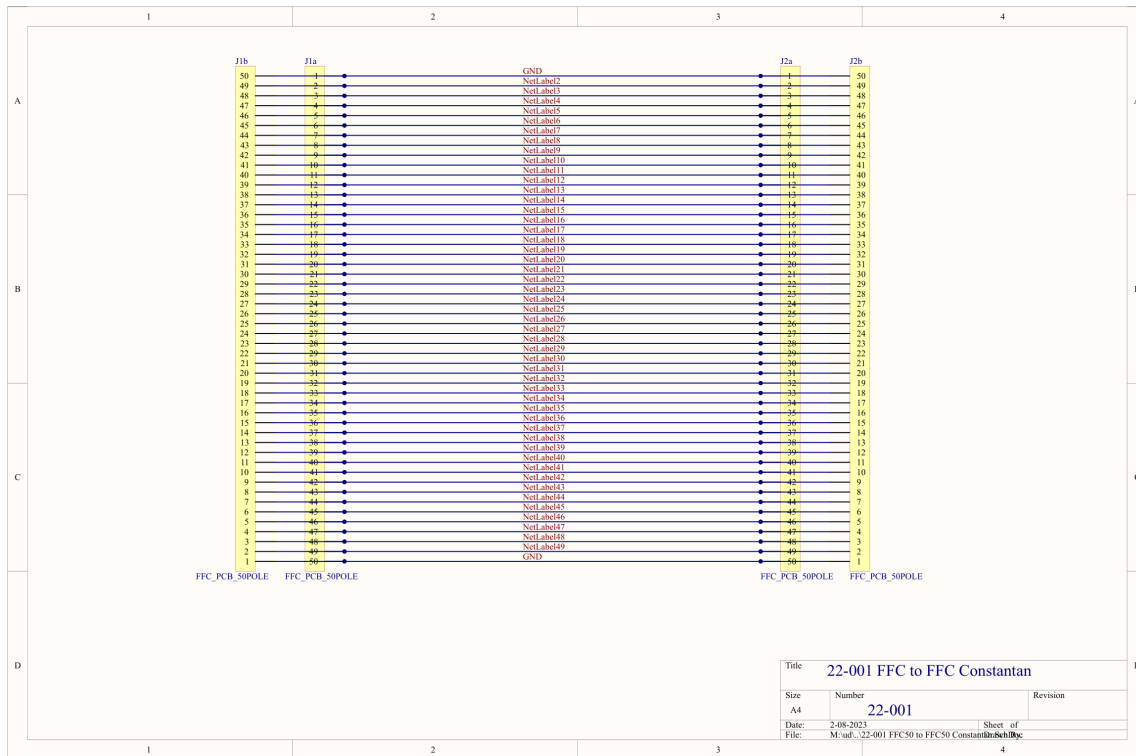

22-002 Sample Board Christian Prosko

Size (LxWxT): 52 x 35 x 1.5 mm / Dielectric: Megtron 6K / Sample area 11x11mm

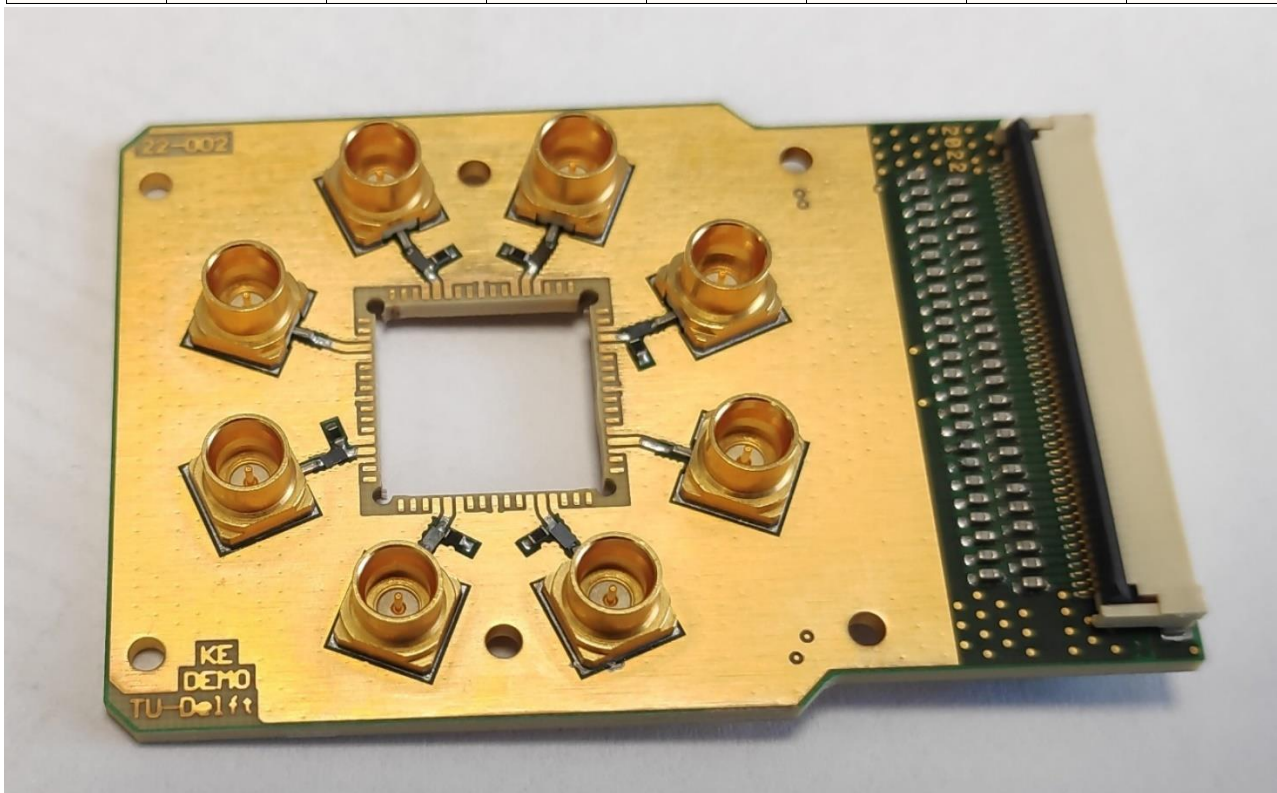
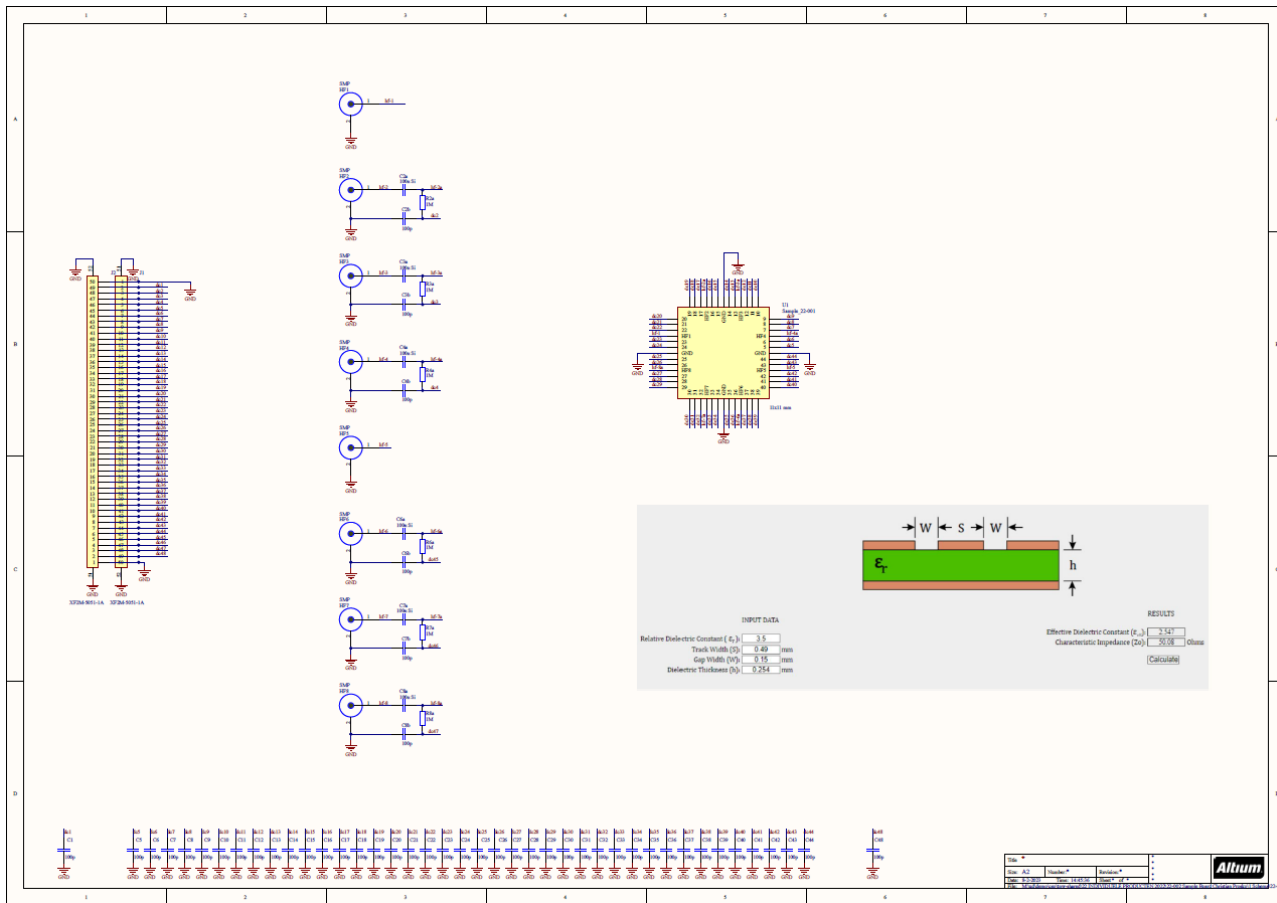

22-004 Sample Board Hans Beukers

Size(LxWxT): 32x22.75x0.50 / Dielectric: Isola-Tera

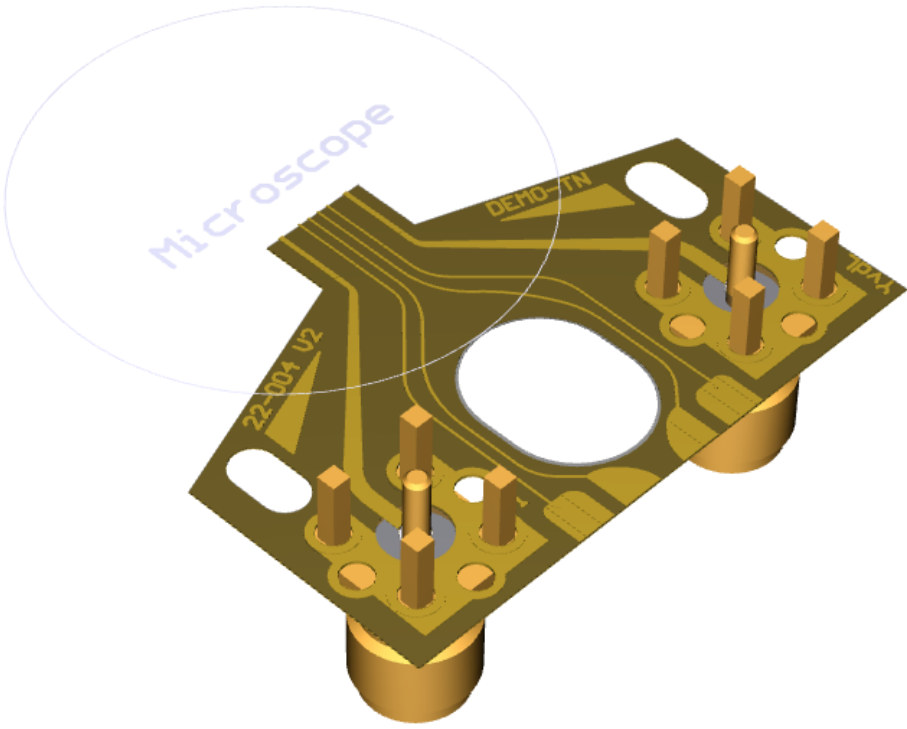
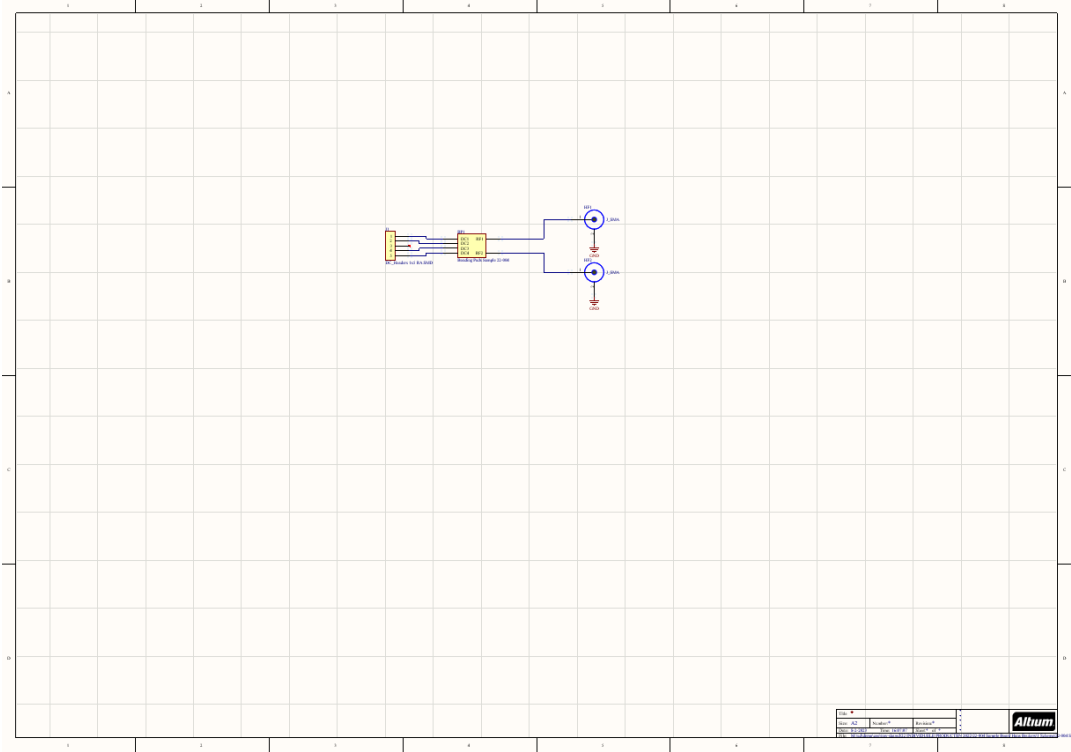

22-006 Test Board Sample Impedance Matching

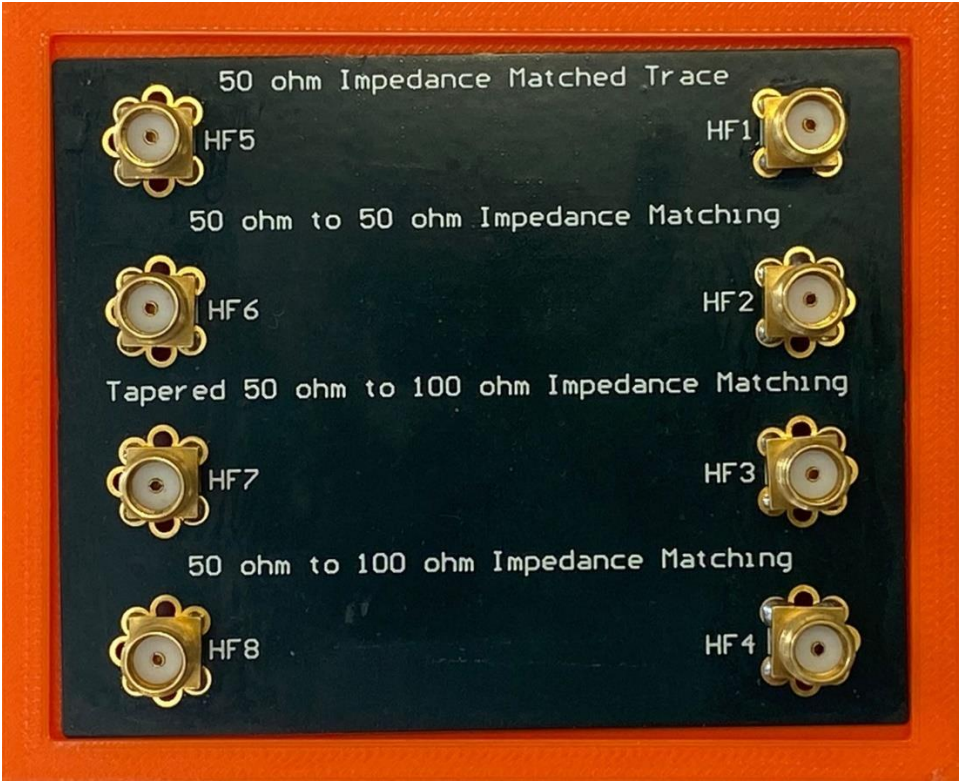
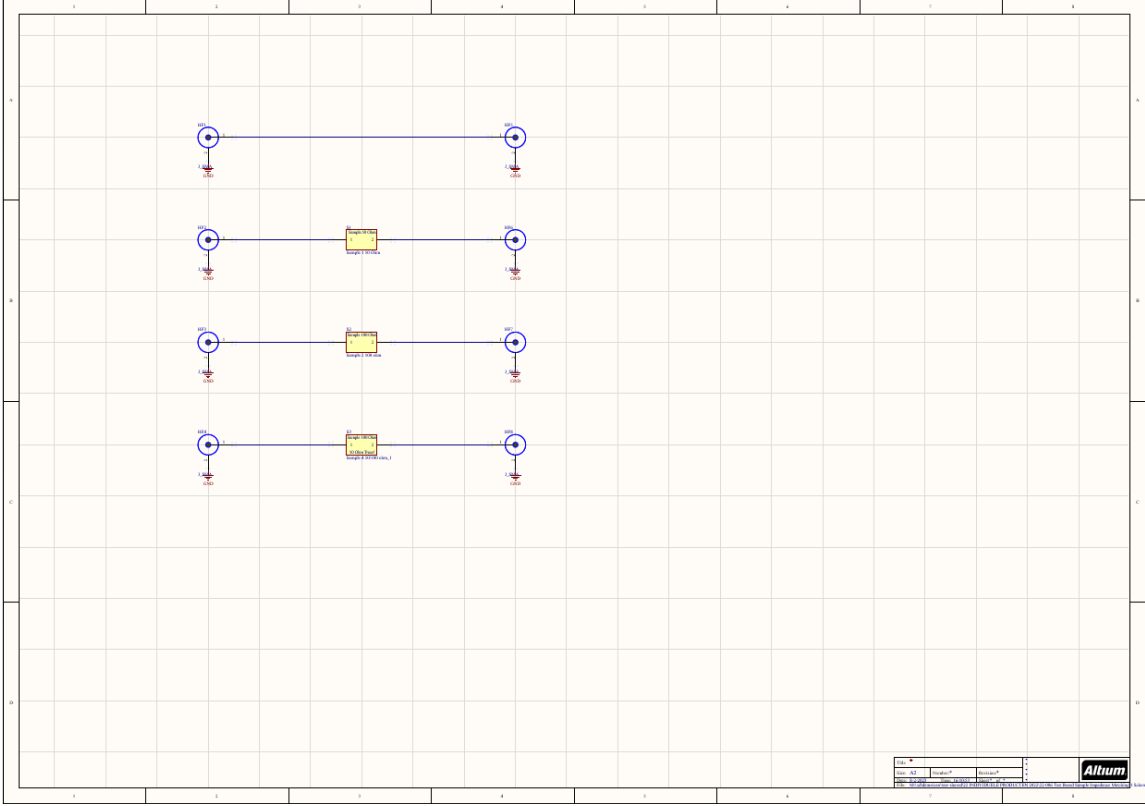

22-017 Fischer to Header

Size (LxWxT): 50 x 50 x 1.55 mm

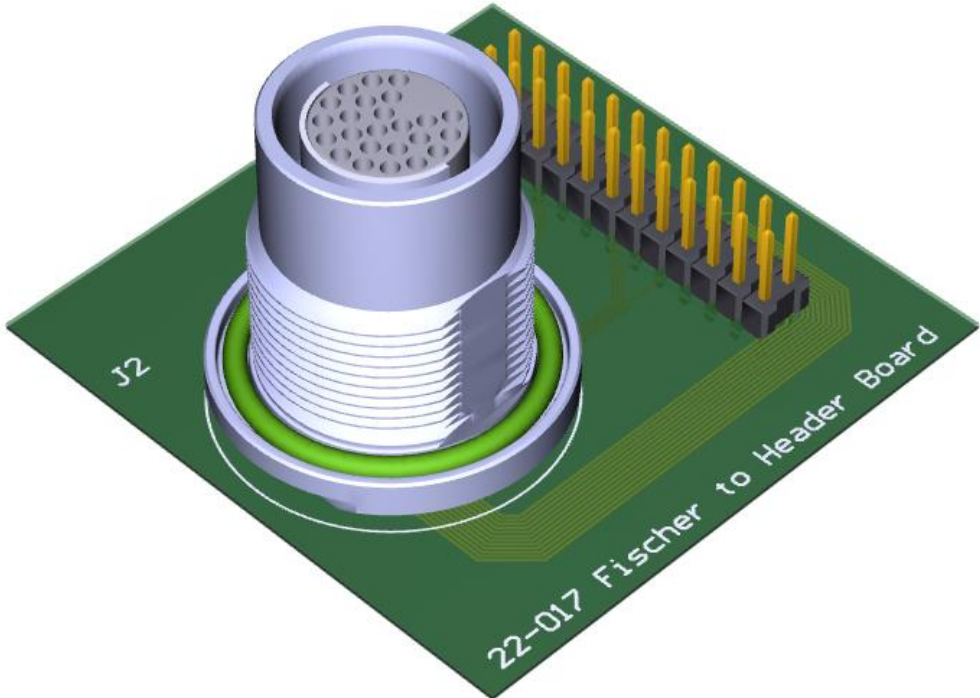
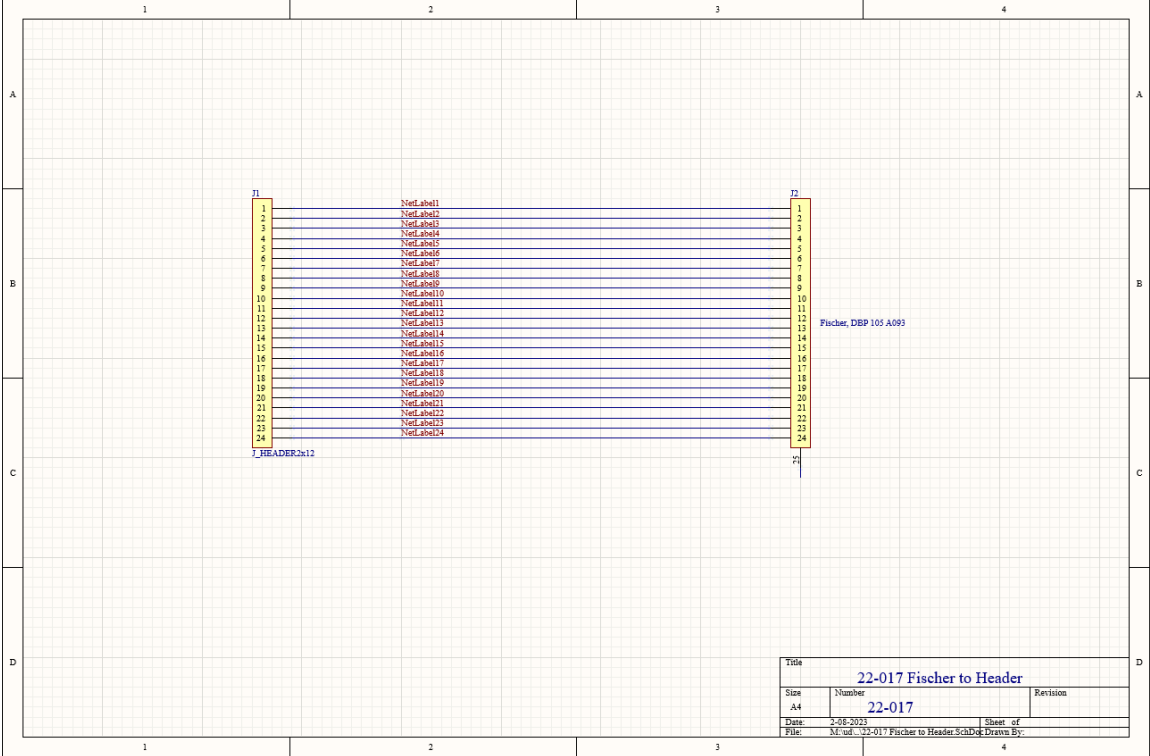

22-020 Power Splitter for Multichannel diplexer

size (LxWxT): 31 x 39 x 3 mm

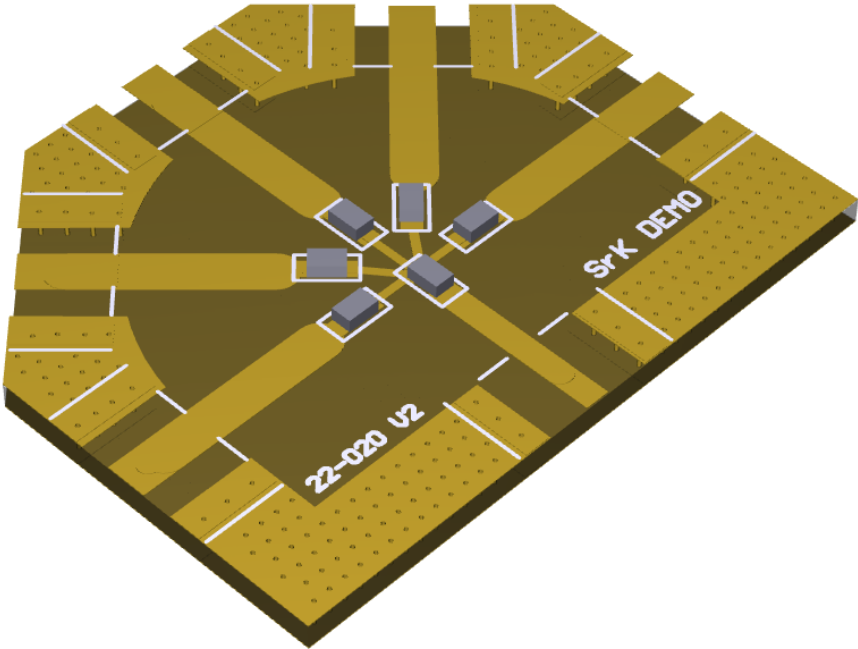
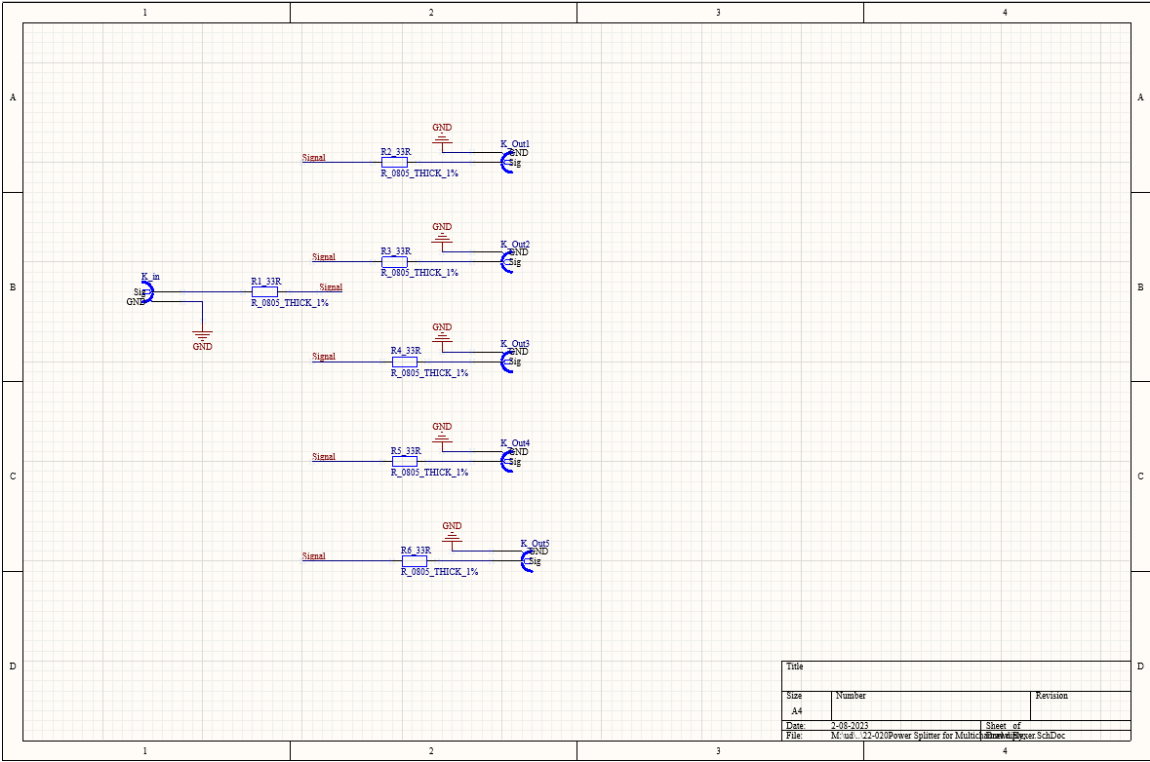

22-019 Spring-load Sample Board

Size(DxT): 31x1.06 / Dielectric: Rogers 4350 / Finish: soft gold without nickel / Sample area 10x10mm / 0.5mm depth milling

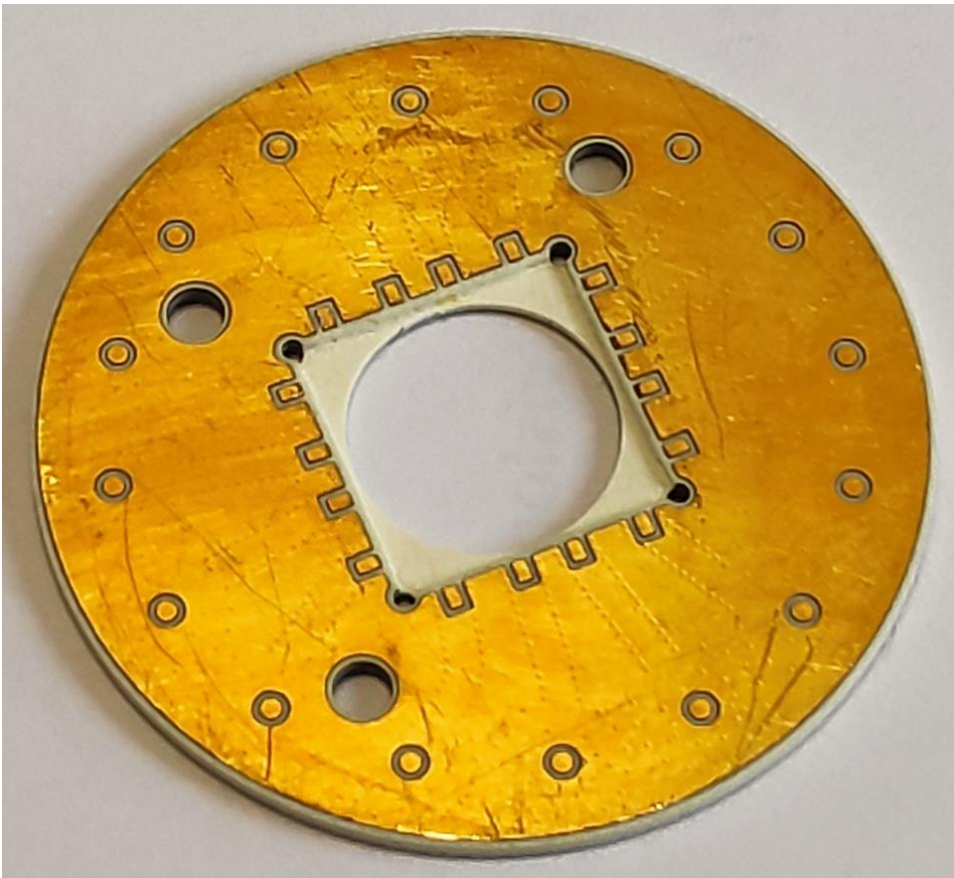
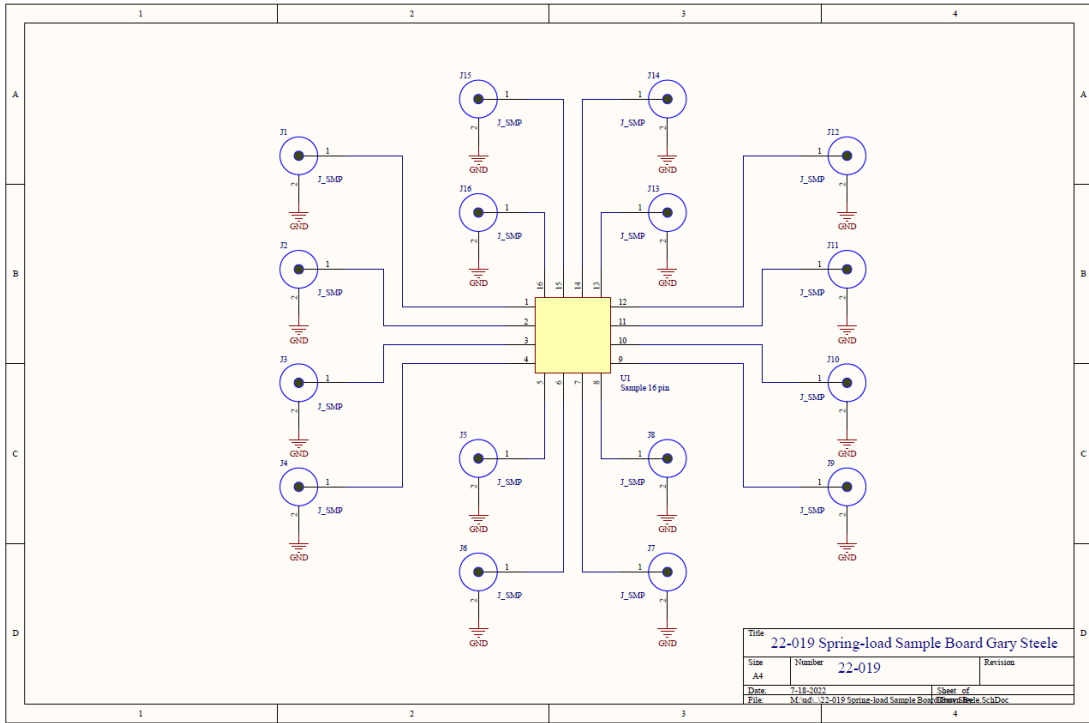

22-021 SPI Option power breakout box

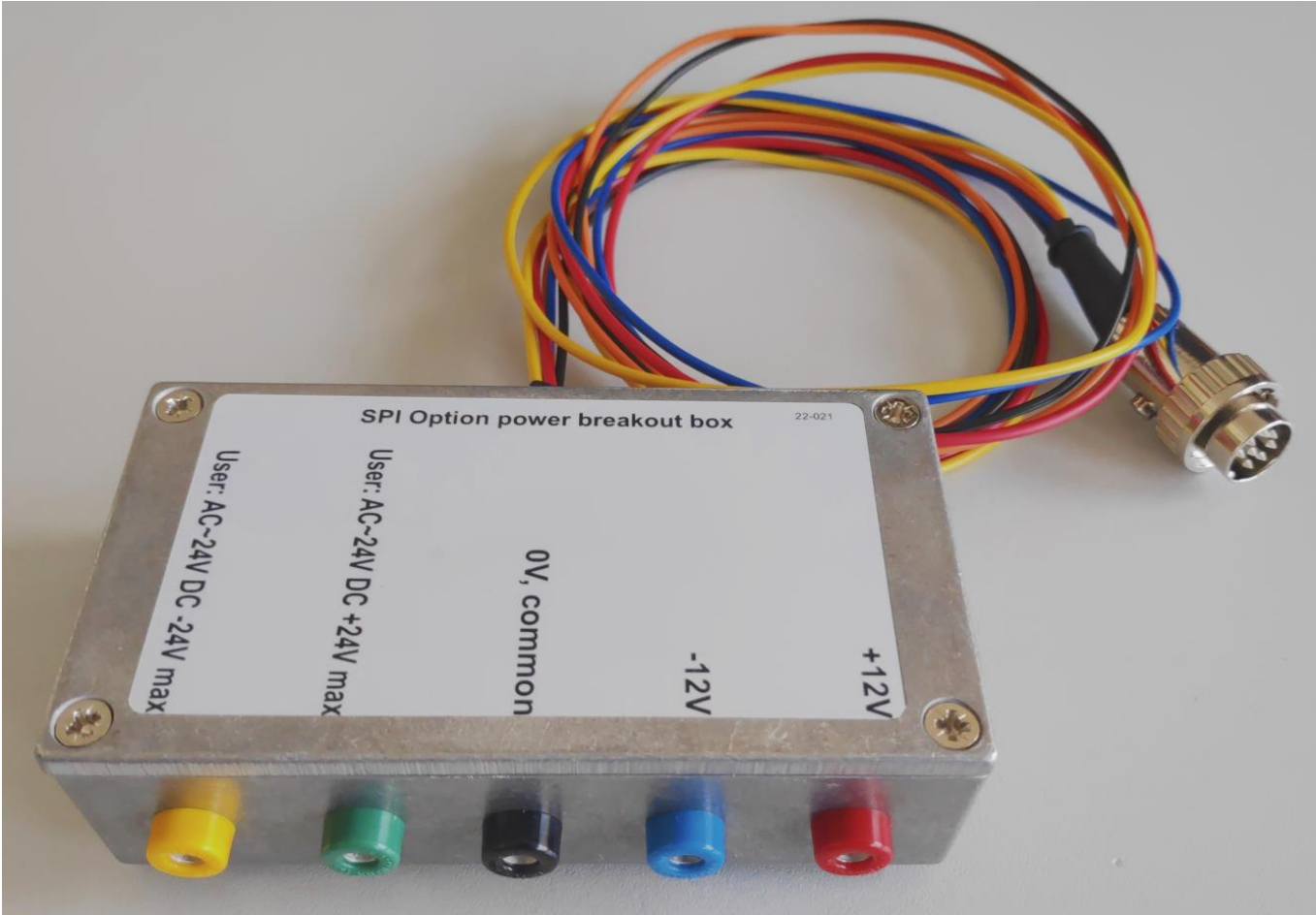

22-025 FFC50 to FFC50 swap

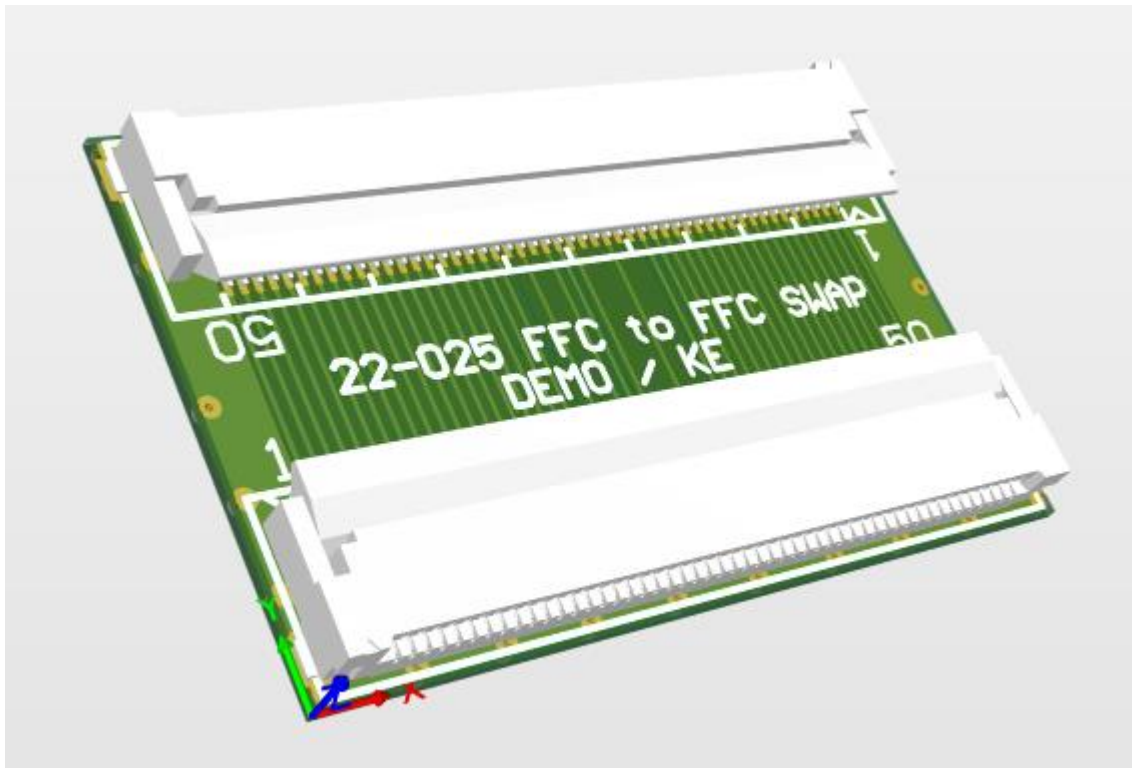
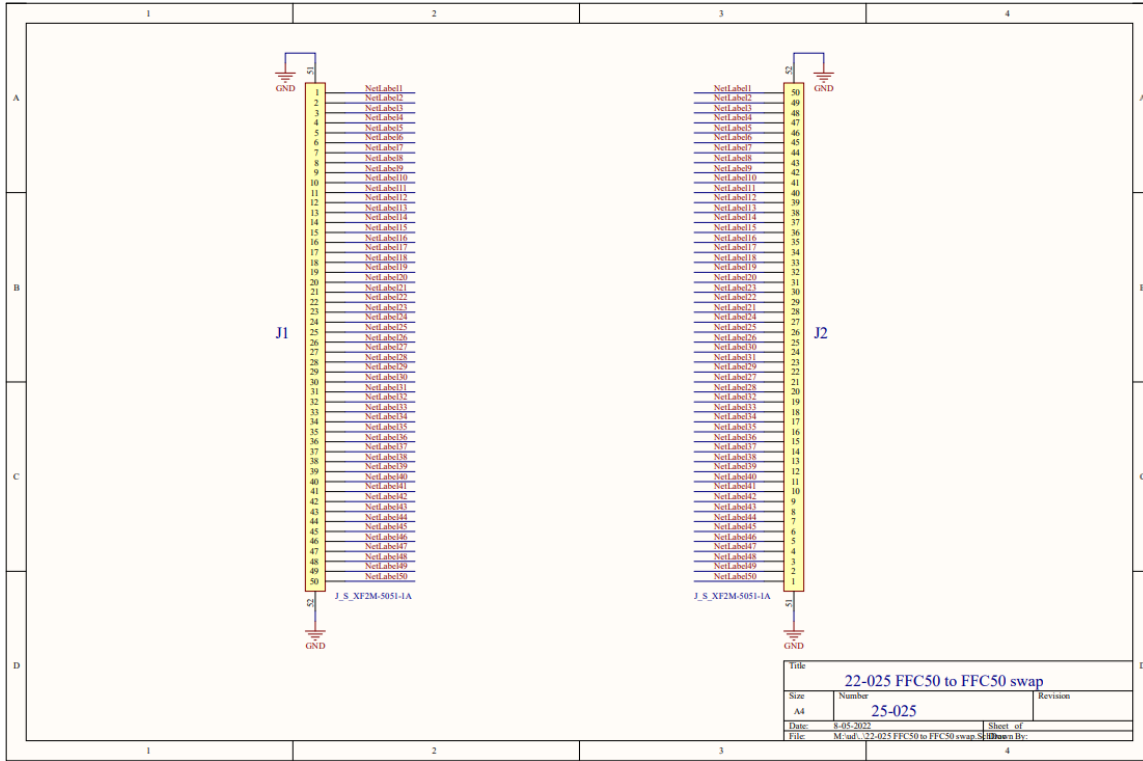

22-026 LD400 Filterboard Will-Nico improved

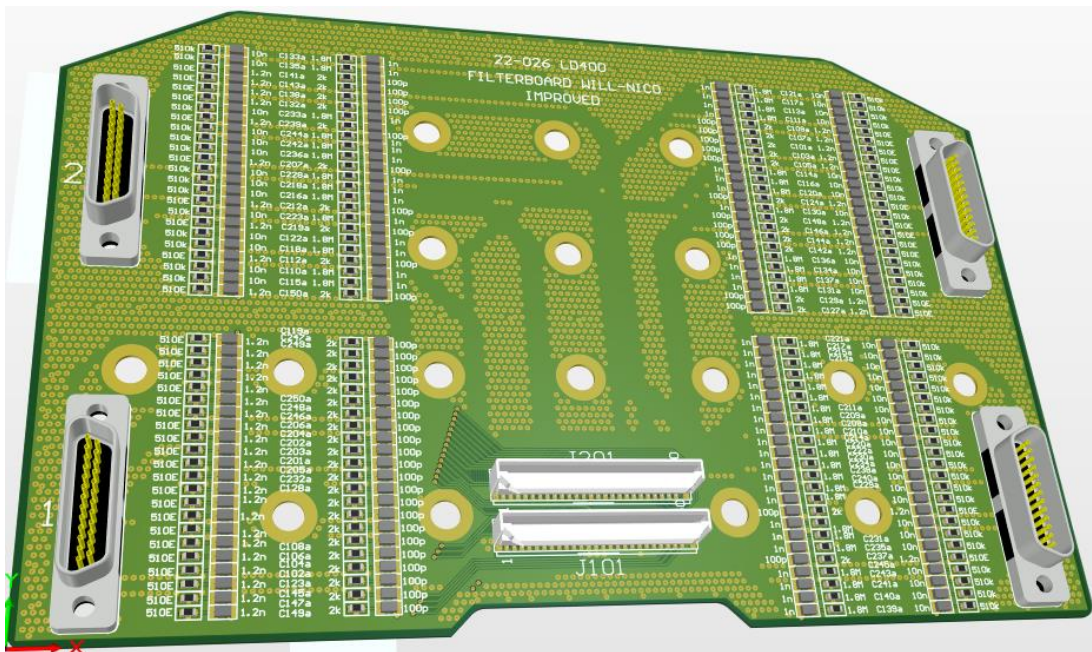
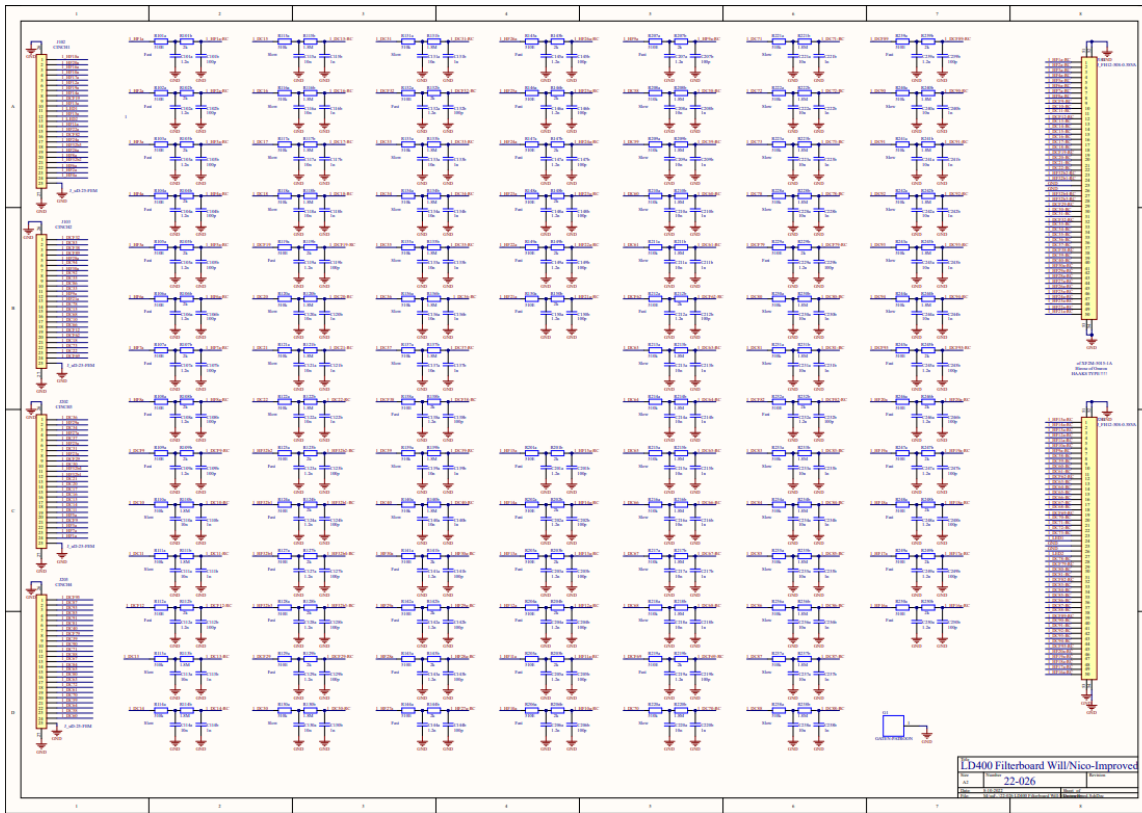

22-027 Plating Current Source

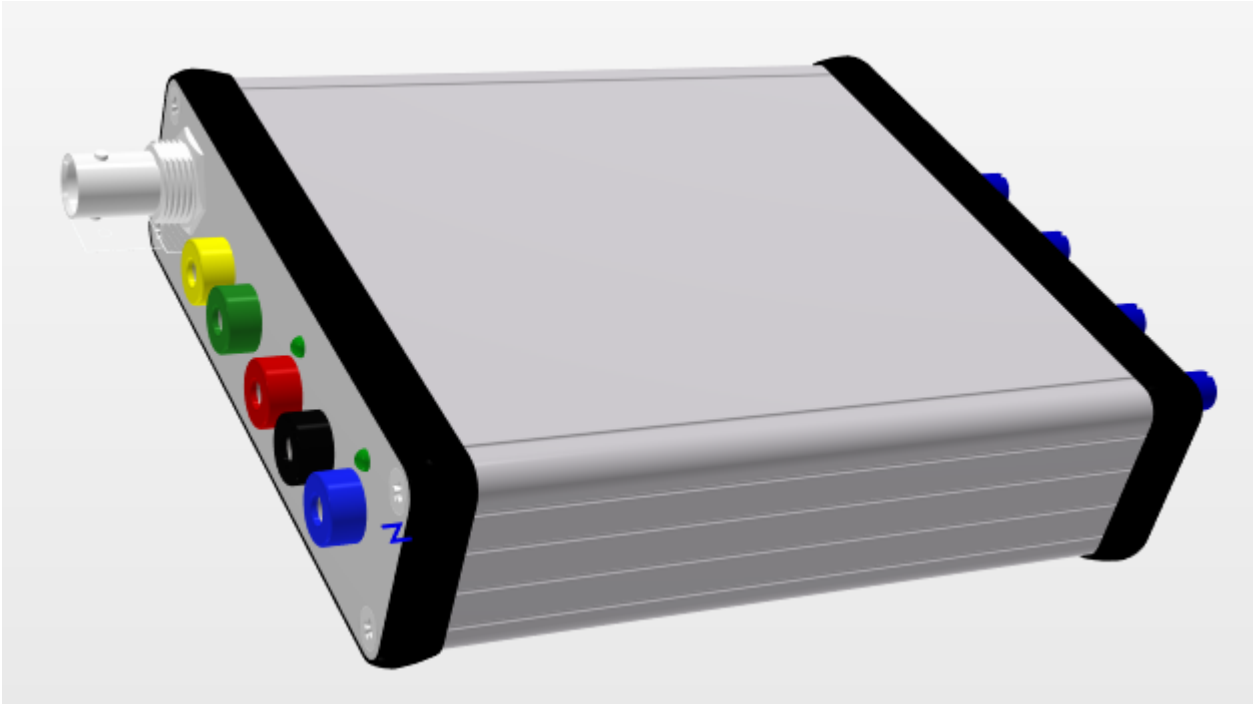
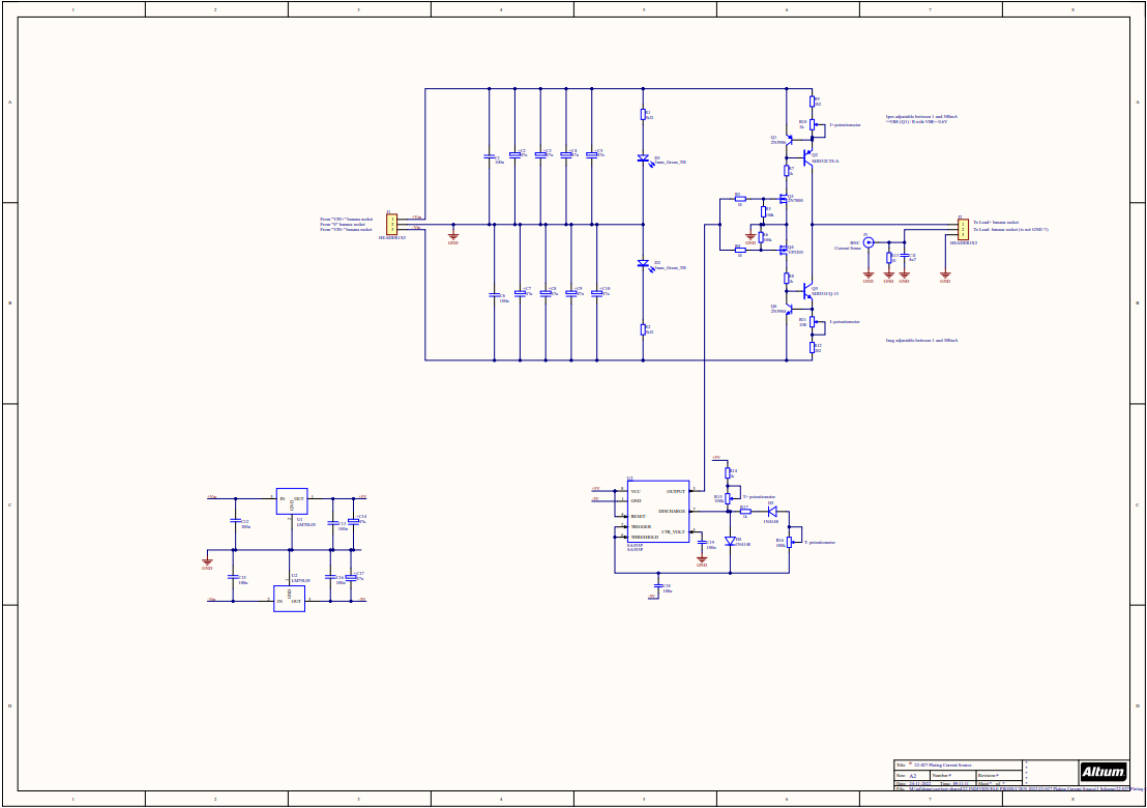

22-028 Remote Valve Control

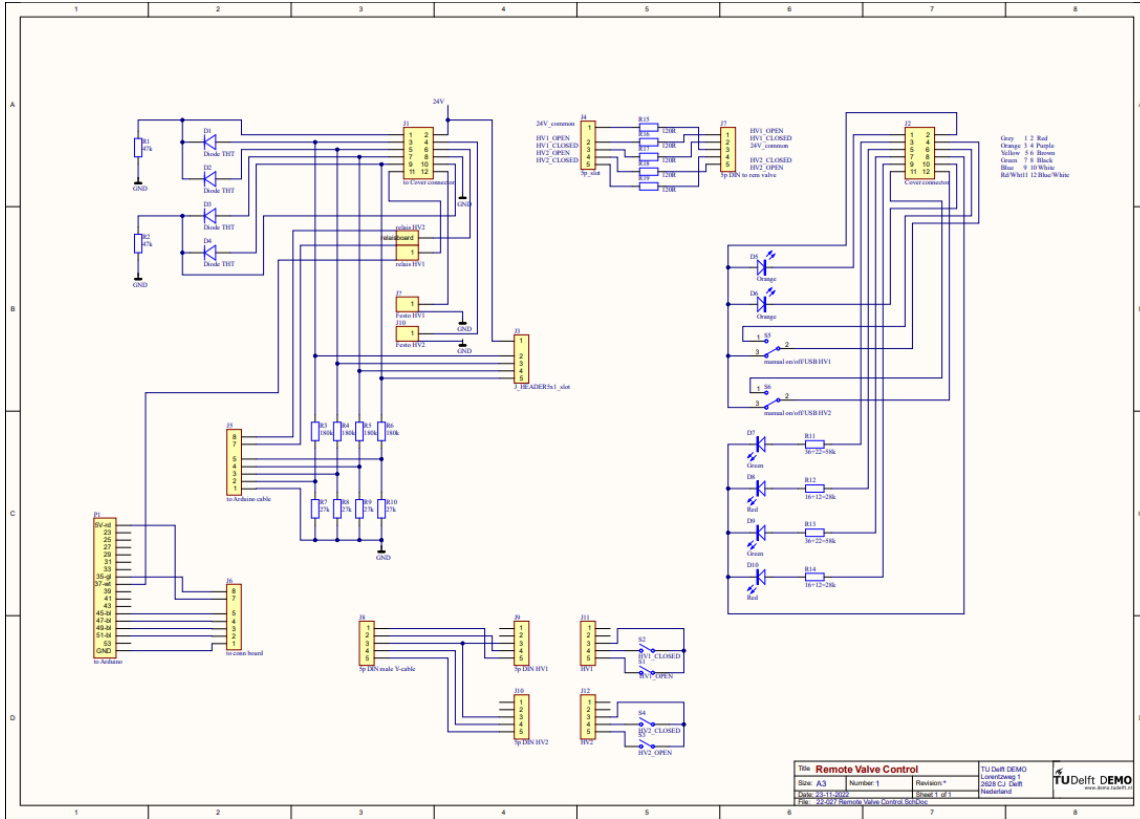

22-030 Expanded FFC Cryo-mux

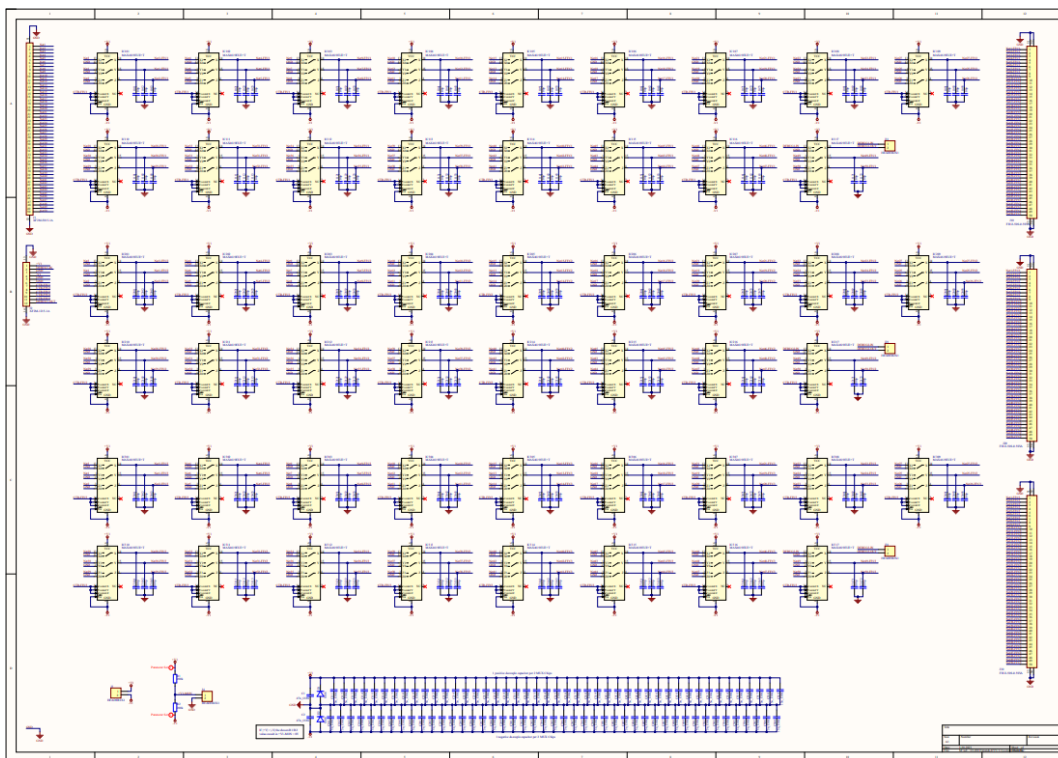

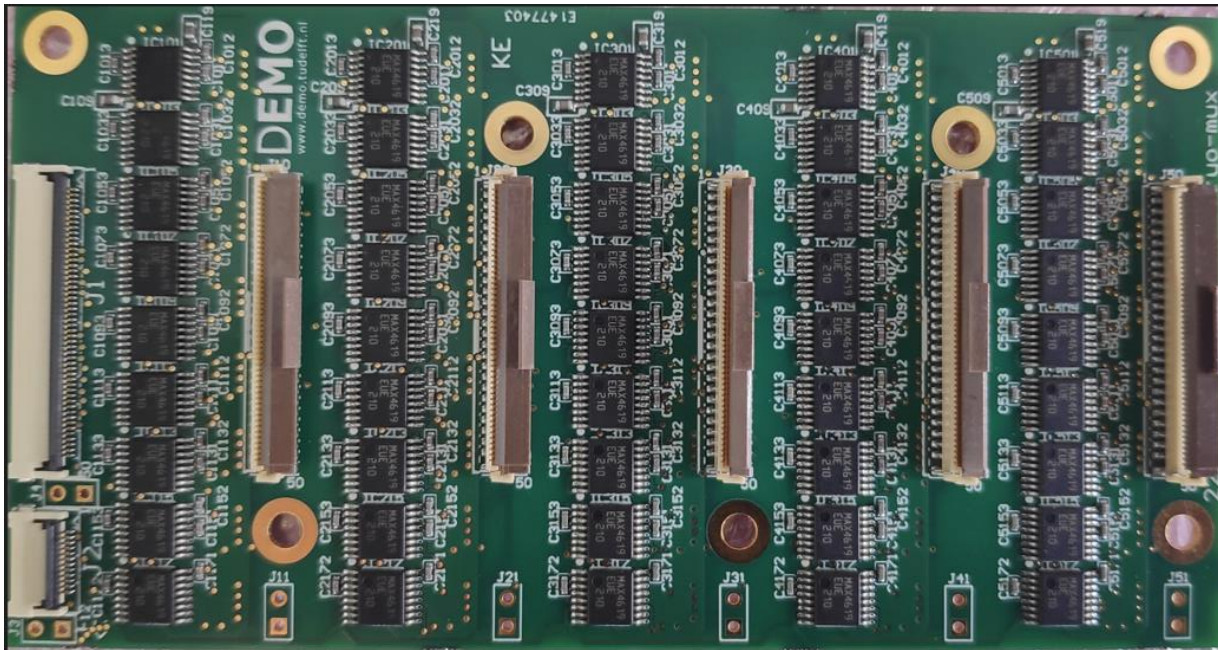
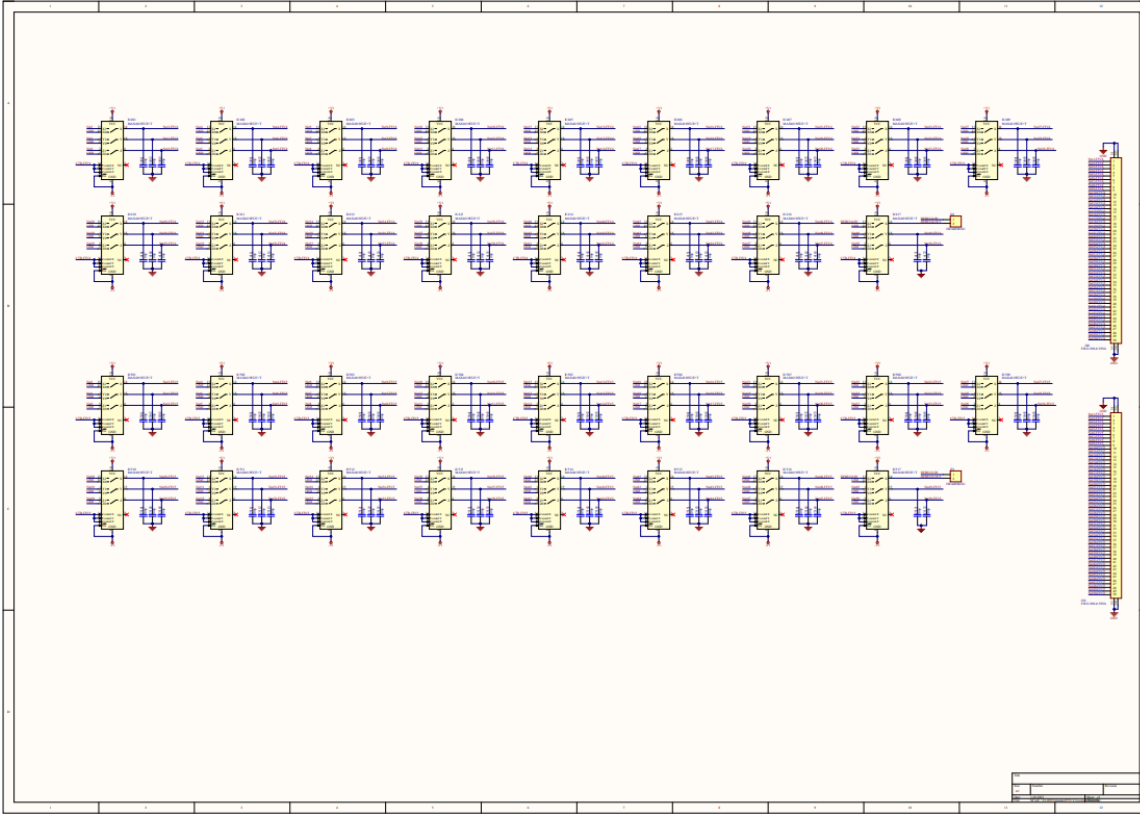

22-031 Sample Board Laurens Feije

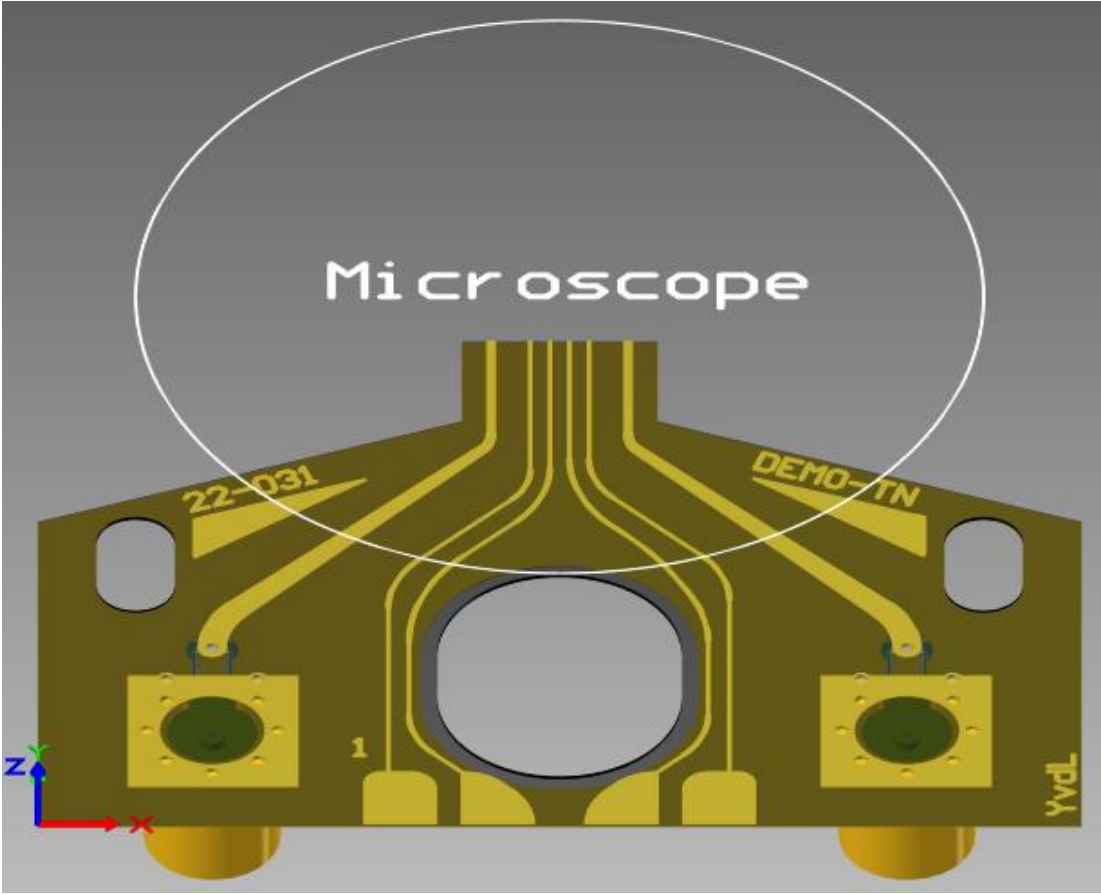
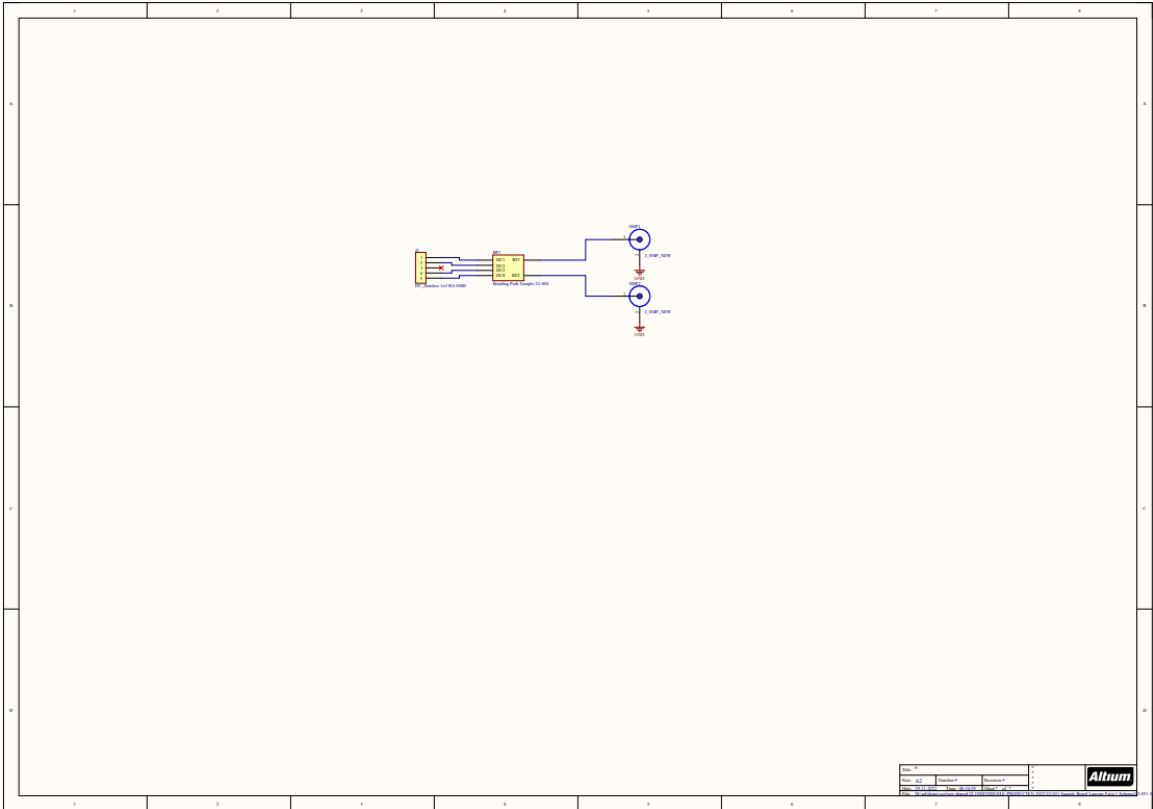

22-032 Sample Board D. van Driel

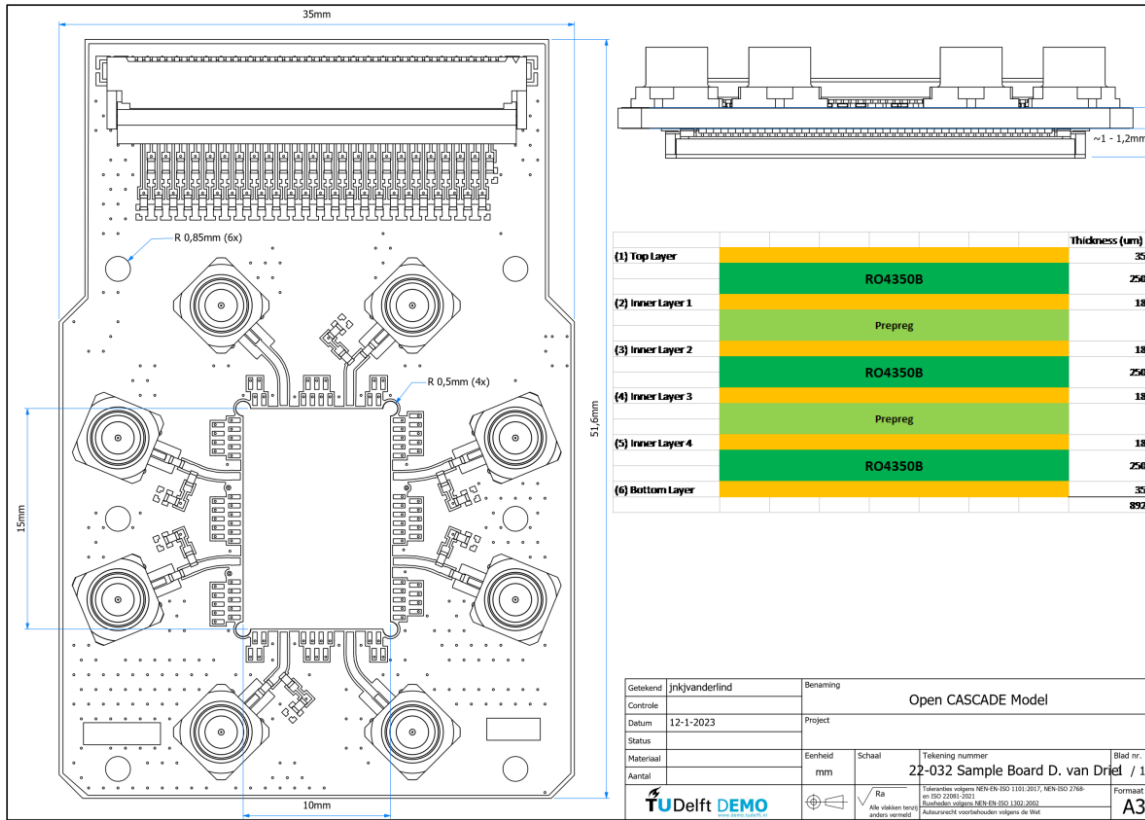

22-033 Sample Boards Martijn Zwanenburg

22-033-1

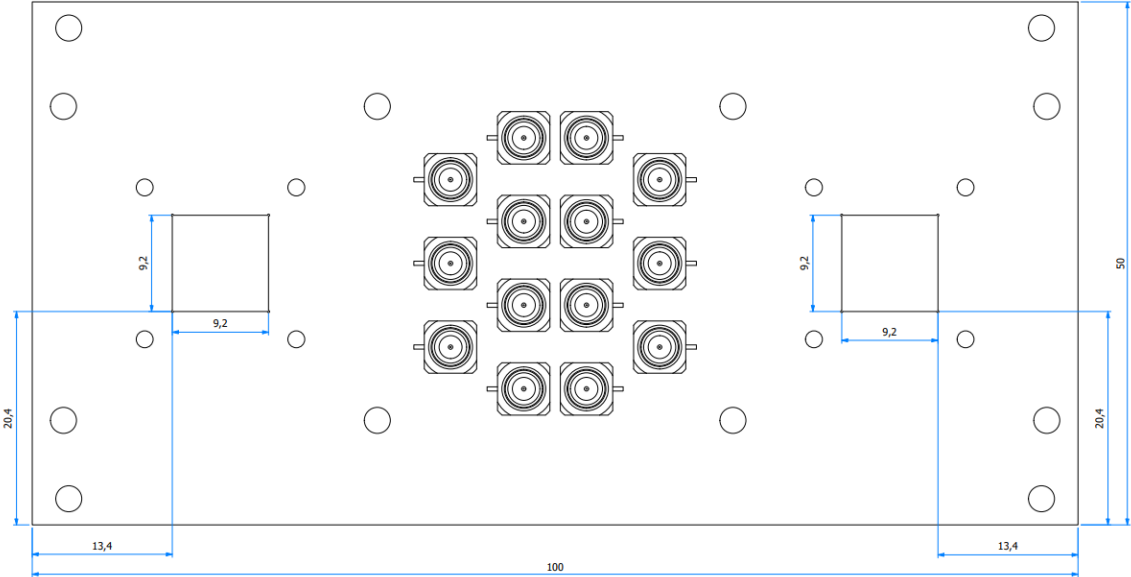
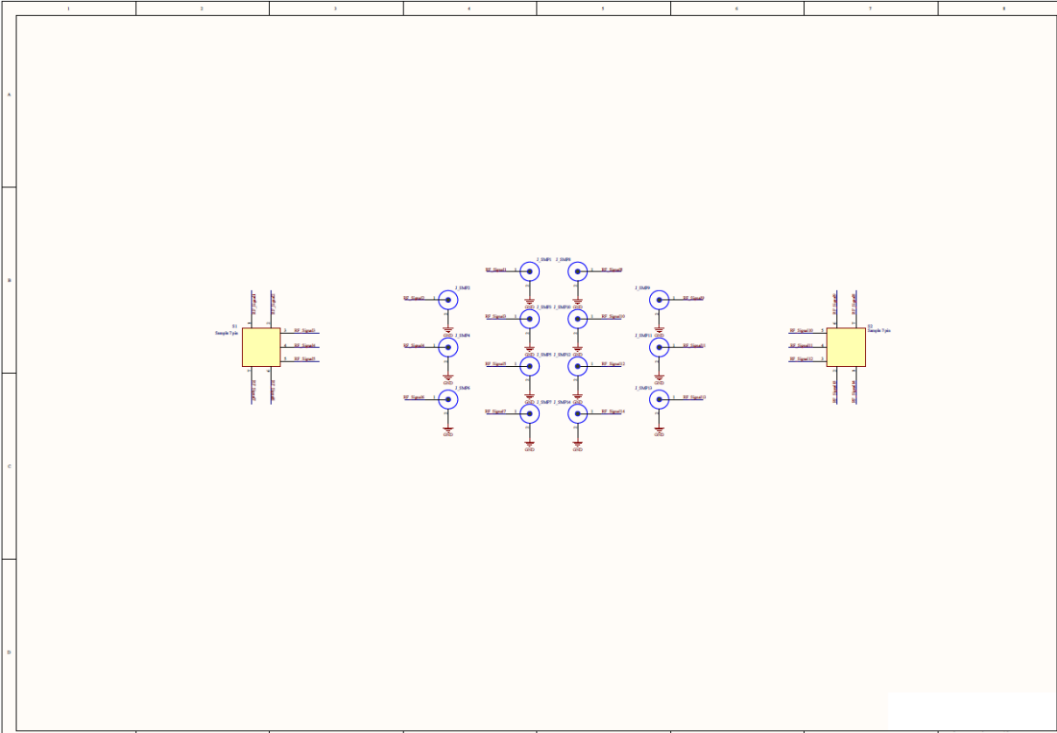

22-033-2

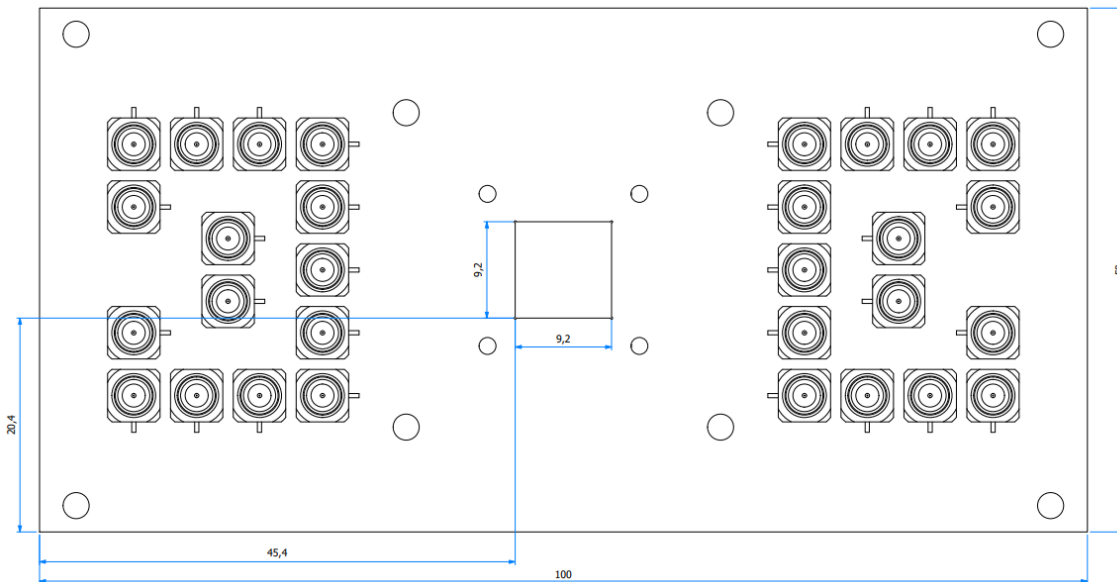
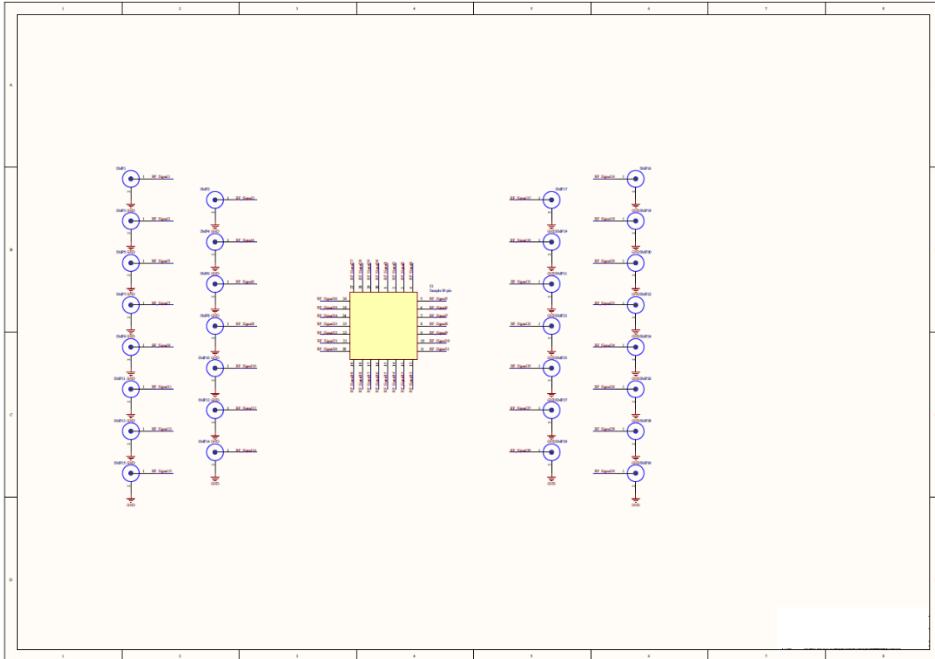

22-035 FFC50 to FFC50 swap Maxim

